

RODAMIENTOS

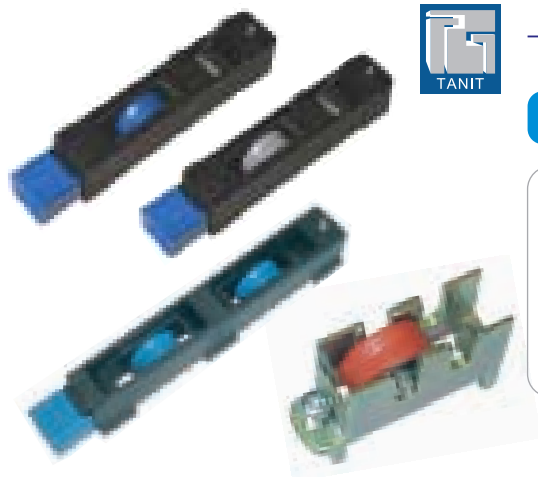

CÓDIGO	DESCRIPCIÓN	KGxCARRO	PERFIL
IMP72098	Caja Fija Simple Bola TR-13 Imola	15 kg.	6908
IMP72096	Caja Reg. Doble Aguja R 42 Ibiza	80 kg.	6910/6915
IMP72097	Caja Reg. Simple Aguja Ibiza T10.6	40 kg.	6910/6915
IMP72095	Caja Reg. Simple Bola Ibiza R40	20 kg.	6910/6915

RODAMIENTOS

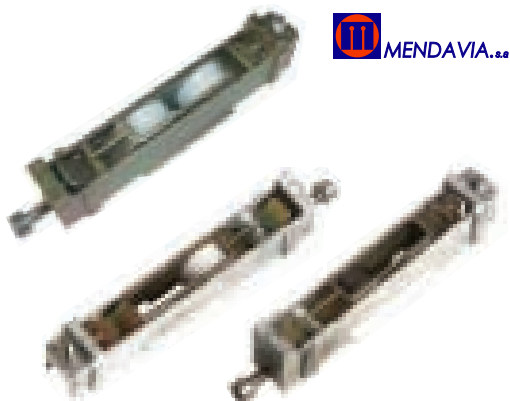

CÓDIGO	DESCRIPCIÓN	KGxCARRO	PERFIL
IMP30930	Caja Reg. Simple Bola 101M-396	15kg.	6908
40130933	Caja Reg. Simple Bola 111E-502	15 kg.	6910/6915
40130931	Caja Reg. Simple Aguja 111E-502A	30 kg.	6910/6915
40130932	Caja Reg. Doble Aguja 112E-502A	60 kg.	6910/6915

RODAMIENTOS



CÓDIGO	DESCRIPCIÓN	KGxCARRO	PERFIL
IMP20911	Caja Fija Simple Bola 1004/20-XCH	20kg.	6908
IMP20919	Caja Regulable Simple Aguja GT25/11-XCH-A	50kg.	6910/6915
IMP20922	Caja Regulable Doble Aguja GTT25/11-A-XCH	100kg.	6910/6915
IMP20923	Caja Fija Doble Aguja TT25/11 A-XCH	100kg.	6910/6915
IMP20928	Caja Fija Simple Aguja T25/11 A-XCH	50kg.	6910/6915

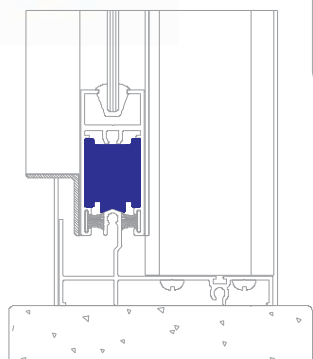

CIERRES



CÓDIGO	DESCRIPCIÓN
--------	-------------

IMP70647	Cierre 2060/A Latodue Blanco
IMP70411	Cierre 2060/A Latodue Negro
IMP70648	Cierre 2060/A Latodue Titanio

IMP70457	Eganche Curvo 2050.11
IMP70456	Keeper 2070.870

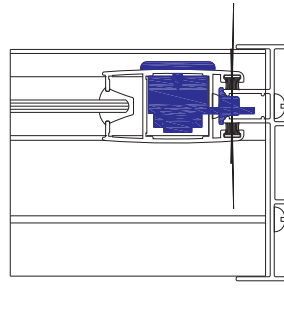

CÓDIGO	DESCRIPCIÓN
--------	-------------

40170401	Cierre 2070.1/M Módulo Negro
40170649	Cierre 2070.1/M Módulo Blanco
40170650	Cierre 2071.1/A Módulo Blanco
40170402	Cierre 2071.1/A Módulo Negro

IMP70453	Eganche Recto 2070-840
IMP72209	Keeper c/allen

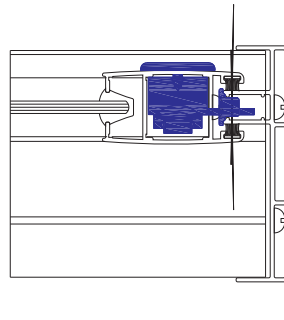

CÓDIGO	DESCRIPCIÓN
--------	-------------

IMP72100	Cierre Omnia Aut. 2048 Blanco
IMP72101	Cierre Omnia Aut. 2048 Negro
IMP72102	Cierre Omnia Aut. 2048 Titanio

IMP72120	Cierre Omnia Manual 2047 Blanco
IMP72121	Cierre Omnia Manual 2047 Negro
IMP72122	Cierre Omnia Manual 2047 Titanio

IMP70457	Eganche Curvo (2050-711)
IMP72209	Keeper c/allen

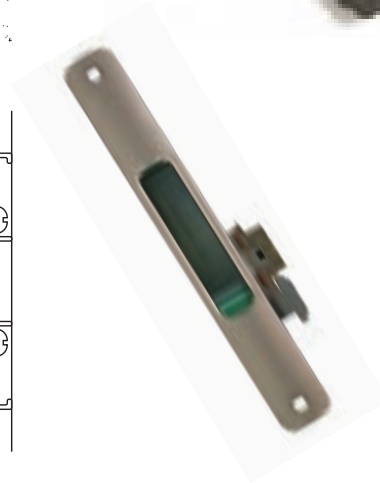
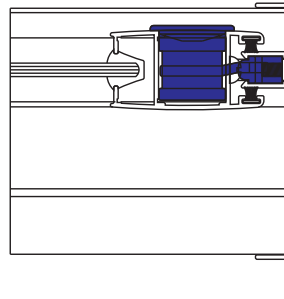

CIERRES



CÓDIGO	DESCRIPCIÓN
--------	-------------

IMP72130	Cierre 6411/A Antepecho (*) Negro
IMP72131	Cierre 6411/A Antepecho (*)Titanio

IMP72125	Cierre 6811/A Terraza (*) Negro
IMP72126	Cierre 6811/A Terraza (*) Titanio

IMP72134	Cierre 6811/M Terraza (*) Negro
IMP72135	Cierre 6811/M Terraza (*) Titanio

(*) incluye engancho y keeper

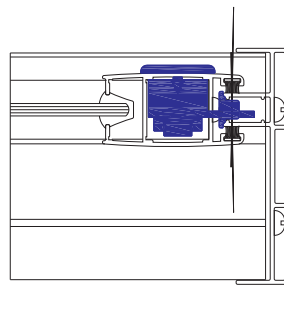

MANILLA

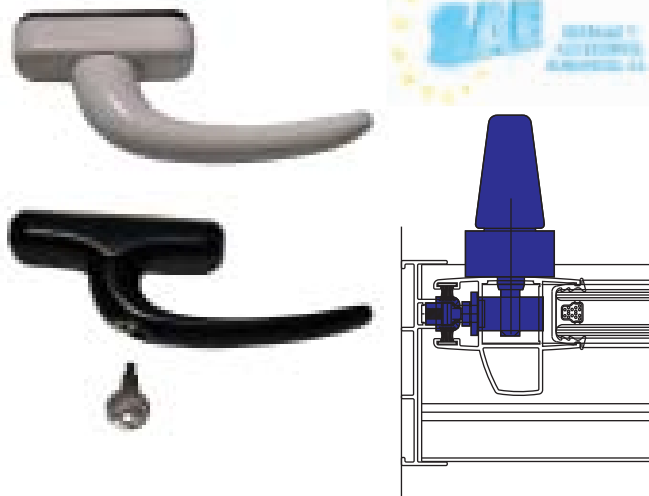

CÓDIGO	DESCRIPCIÓN
--------	-------------

IMP72150	Manilla Martellina Romy 3040 Blanco
IMP72153	Manilla Martellina Romy 3040 Negro
IMP72152	Manilla Martellina Romy 3040 Titanio
IMP72154	Manilla Martellina Sissy 3052 c/llave Negro
IMP72155	Manilla Martellina Sissy 3052 c/llave Blanco

KIT CIERRE UNIPUNTO PERFIL 6911/6916



CÓDIGO	DESCRIPCIÓN	CANTIDAD
--------	-------------	----------

IMP72200	Mecanismo Unipunto 8626	1
IMP72211	Keeper Marco 8630	1
IMP72220	Seguro Antielevación 8631	1
40172221	Suple 6903 keeper	1
40172204	Golilla de Ajuste cierre	4

KIT CIERRE UNIPUNTO PERFIL 6937/6938

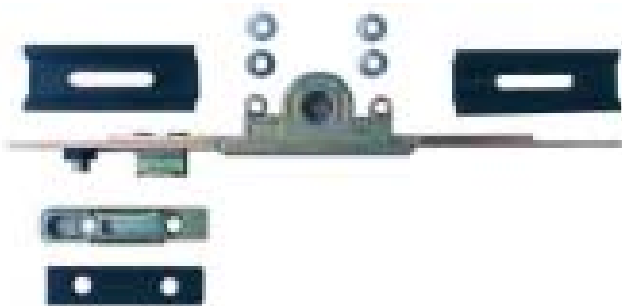

CÓDIGO	DESCRIPCIÓN	CANTIDAD
--------	-------------	----------

IMP72200	Mecanismo Unipunto 8626	1
IMP72211	Keeper Marco 8630	1
IMP72220	Seguro Antielevación 8631	1
40172221	Suple 6903 keeper	1
40172204	Golilla de Ajuste cierre	4
IMP72219	Suple 8638	2

KIT CIERRE BIPUNTO PERFIL 6937/6938



CÓDIGO	DESCRIPCIÓN	CANTIDAD
--------	-------------	----------

IMP72201	Mecanismo 2 puntos 8628	1
IMP72211	Keeper Marco 8630	2
IMP72220	Seguro Antielevación 8631	1
40172221	Suple 6903 keeper	2
40172204	Golilla de Ajuste cierre	4
IMP72219	Suple 8638	4

SISTEMA MULTIPUNTO DE CREMONA CORREDERA

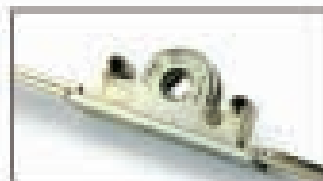

ESCUADRAS DE INYECCIÓN

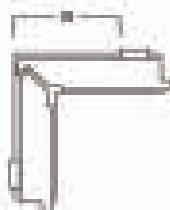
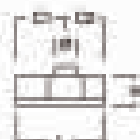

BISAGRAS PARA CÁMARA EUROPEA



KIT PARA VENTANA PRACTICABLE



UDINESE KIT MANILLA UNIPUNTO

CÓDIGO	DESCRIPCIÓN
--------	-------------

IMP72172	Kit Manilla Cremona 6635XL Negro
IMP72173	Kit Manilla Cremona 6635XL Bronce
IMP72174	Kit Manilla Cremona 6625XL Negro



ALBANY

TIRADOR

CÓDIGO	DESCRIPCIÓN
--------	-------------

40172143	Tirador Albany Negro
----------	----------------------

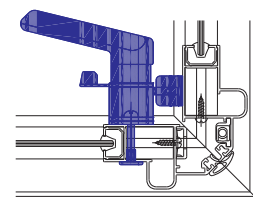

KIT TIRADOR

CÓDIGO	DESCRIPCIÓN
--------	-------------

IMP72212	Keeper Cierre Albany
IMP70412	Pestillo Cámara Europea H-49

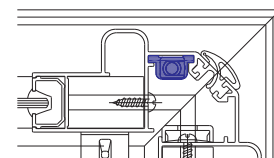

FELPAS

CÓDIGO	DESCRIPCIÓN
ISF54P55	Felpa 5x5 Fin Seal 3P (Rollo 300mt.) Negro
ISF54P78	Felpa 7x8 Fin Seal (Rollo 300mt.) Negro

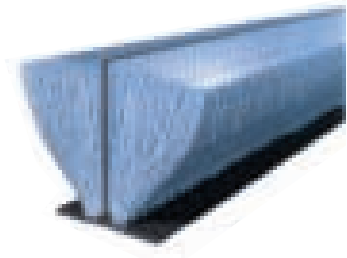
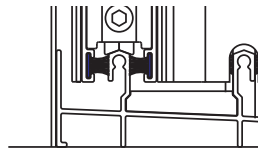
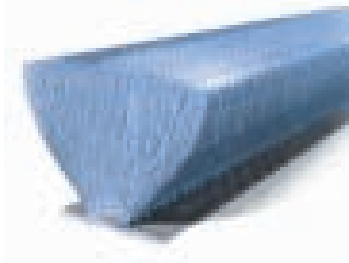
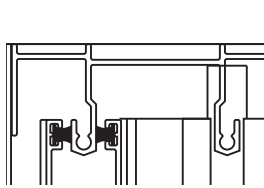

BURLETES



CÓDIGO	DESCRIPCIÓN
IMP72061	Burlete en "U" 4 mm SE-125 EPDM Negro
IMP72062	Burlete en "U" 5 mm SE-430 EPDM Negro
IMP72063	Burlete en "U" 6 mm SE-397 EPDM Negro
IMP72076	Burlete Aleta selladora SE-429 Negro
IMP72050	Burlete Base SE-427 EPDM Negro
IMP72079	Burlete Cuña 4 mm SE-019 EPDM Negro
IMP72080	Burlete Cuña 5 mm SE-027 EPDM Negro
IMP72081	Burlete Cuña 6 mm SE-008 EPDM Negro
IMP72077	Burlete Cuña SE-009 EPDM VD 4 mm Negro
IMP72078	Burlete Cuña SE-025 EPDM VD 5 mm Negro
IMP72058	Burlete Termopanel SE-399 EPDM Negro
IMP72086	Burlete Cuña SE-456 EPDM Negro
IMP72087	Burlete DC SE-457 EPDM Negro

BURLETES EN "U" VIDRIO MONOLITICO GALCE 9,6 MM.



SE-125
VIDRIO 4 mm.

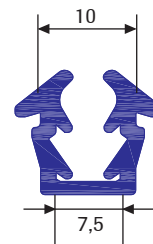

SE-430
VIDRIO 5 mm.

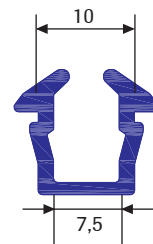

SE-397
VIDRIO 6 mm.

BURLETES EN "U" DOBLE VIDRIO

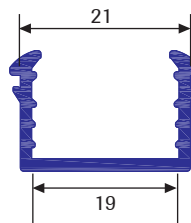

SE-399
TERMOPANEL 18 mm.

BURLETES ESTANQUIDAD

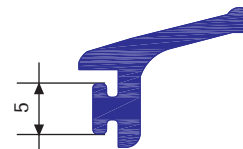

SE-429
BASE 5,8 mm.

ACRISTALAMIENTO BASE

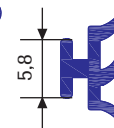

SE-427

ACRISTALAMIENTO CUÑA

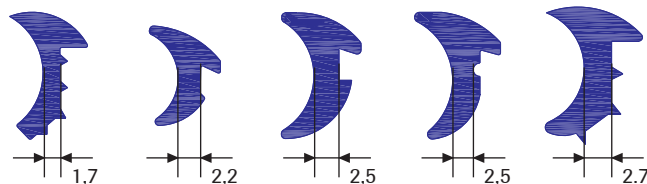

SE-008 SE-025 SE-019 SE-027 SE-009

BURLETES ESPECIALES PARA ESQUINA ABIERTA

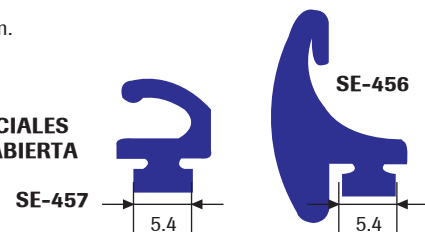

SE-457

SE-456

EMPAQUETADURAS

CÓDIGO

DESCRIPCIÓN

40120845 Empaquetadura adhesiva p/6901 Negro
 40120846 Empaquetadura adhesiva p/6902 Der. Negro
 40120847 Empaquetadura adhesiva p/6902 Izq. Negro
 40120820 Empaquetadura adhesiva p/6920 Der/Izq
 40120821 Empaquetadura adhesiva p/6921 Der/Izq
 40120835 Empaquetadura adhesiva p/6935 Der/Izq
 40120838 Empaquetadura adhesiva p/6918 Der/Izq

40172314 Empaquetadura Perfil 6918 Der. Negro
 40172315 Empaquetadura Perfil 6918 Izq. Negro
 40172316 Empaquetadura Perfil 6921 Der. Negro
 40172317 Empaquetadura Perfil 6921 Izq. Negro
 40172318 Empaquetadura Perfil 6935 Der. Negro
 40172319 Empaquetadura Perfil 6935 Izq. Negro

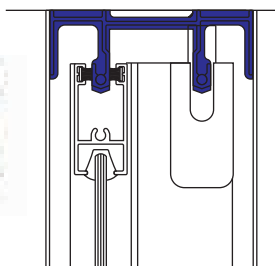
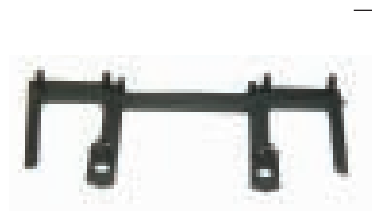

Empaquetadura adhesiva p/6901

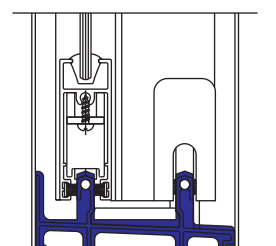

Empaquetadura adhesiva p/6902

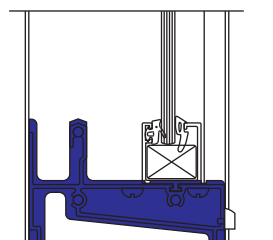
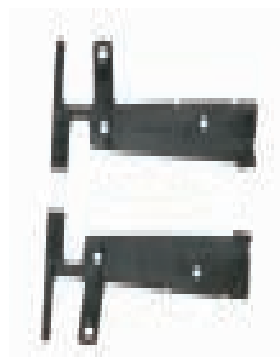

Empaquetadura adhesiva p/6918

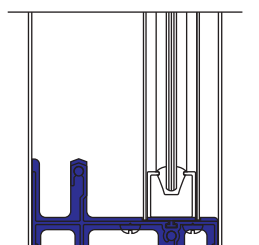

Empaquetadura adhesiva p/6921

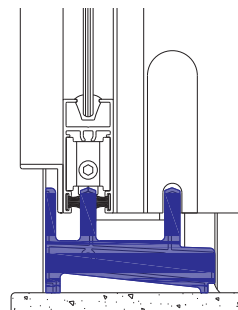
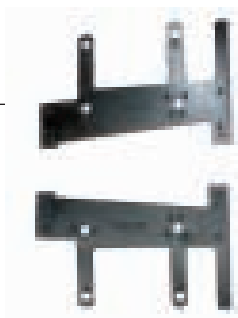

Empaquetadura adhesiva p/6935

LÍDERES EN DISEÑO Y PRECISIÓN



Desde 1969 pensando en ti,
ofreciéndote calidad, servicio,
innovación, investigación y desarrollo

GRACIAS POR CONFIAR EN NOSOTROS

**Herrajes para carpintería de aluminio, PVC, cristal y madera.
(conjuntos con rodamientos especiales de bolas y agujas)**

 manufacturas
pabose

ACCESORIOS

CÓDIGO

DESCRIPCIÓN

40172300	Calzo Monorriel
IMP70330	Deflector de Viento
40172350	Guía (contratapa)
40172351	Guía (tapa)
40172384	Tapa refuerzo derecha/izquierda
40172382	Tapa refuerzo (receptora de condensación) der./izq.
40172385	Tope amortiguador Perfil 6903 antepecho
40172386	Tope amortiguador Perfil 6903 terraza
40172390	Tope estanco 6918/6921
40172392	Tope estanco Perfil 6901 Superior
40172393	Tope estanco Perfil 6901 Inferior
40172394	Tope estanco inferior Perfil 6935
40172399	Taco Hoja Fija PVC Rígido
40172301	Clip simple



Calzo Monorriel

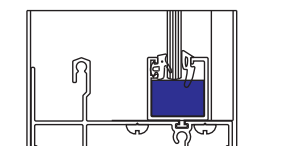

Deflector de Viento

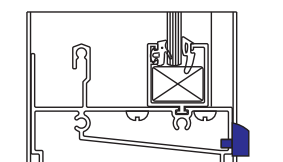

Guía (contratapa) / (tapa)

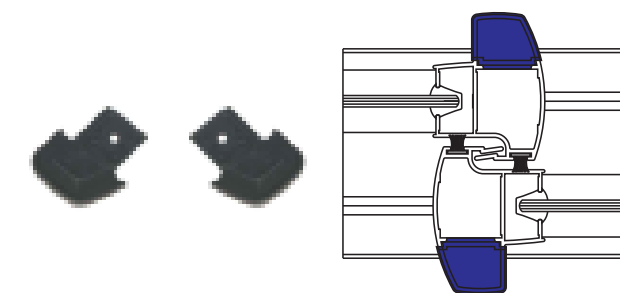
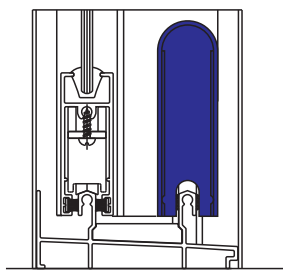

Tapa refuerzo derecha/izquierda

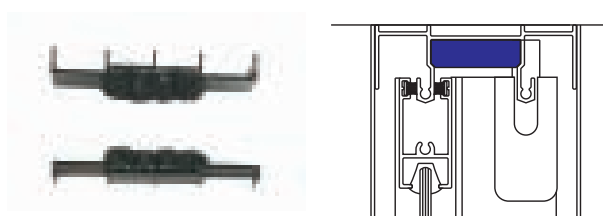

Tope estanco

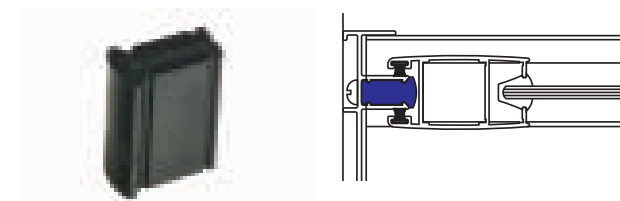

Tope amortiguador Perfil 6903 antepecho

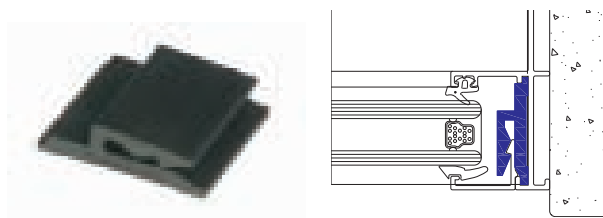

Clip simple

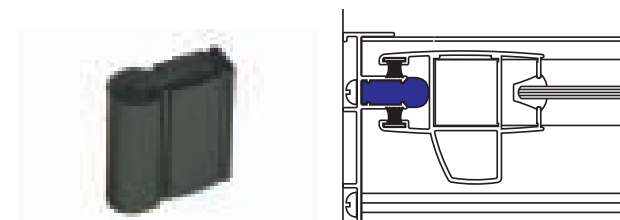

Tope amortiguador Perfil 6903 terraza

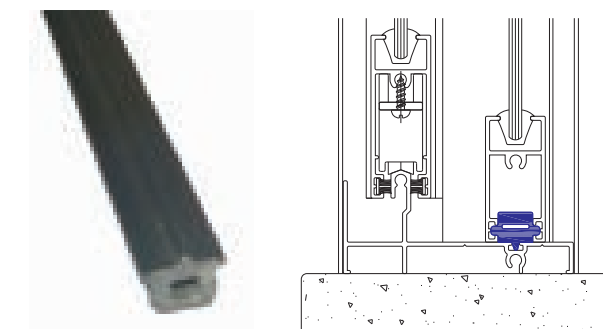

Taco hoja fija

Máxima excelencia en sistemas para cerramientos.

En su completa línea de accesorios para el Sistema Xelentia, además de calidad a buen precio.

Udinese ha incorporado otras ventajas adicionales como lo es el concepto de "Conjunto Armónico" que consiste en mantener el mismo modelo de manilla en distintas aplicaciones de servicio permitiendo uniformidad visual y estética en un mismo ambiente y facilidad de montaje con la mayoría de los contraenganches de sobreponer o acanalados que requieren mínimo mecanizado en los perfiles.



Xelentia
SISTEMA

Udinese garantiza sus
productos por 5 años